

NEW KEYS COLLECTION

2024
APRIL

NR.
04



NETWORK WITH US













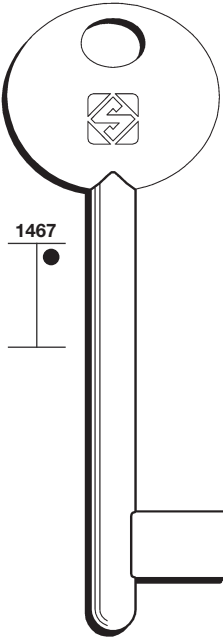

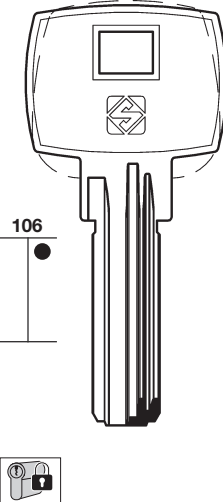

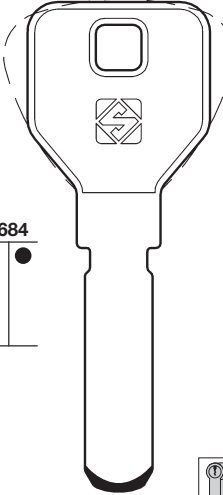
2024 NEW KEYS COLLECTION

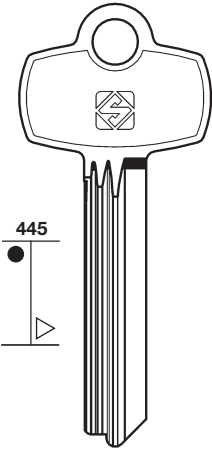
NEW KEYS

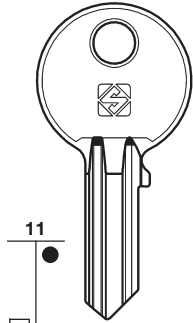

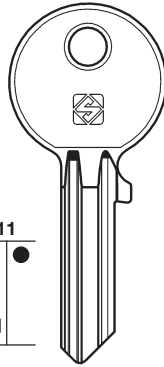
Silca key blanks are compatible with third party manufacturers' cylinders specified here below:

AGB*	AL AHRAM*	BANHAM*	
 <p>1467</p> <p>6AGB7</p>  <p>8 052782 040738</p> <p>Box of 25</p>	 <p>106</p> <p>AHR4</p>  <p>8 052782 041711</p> <p>Box of 50</p>	 <p>1684</p> <p>BM3</p>  <p>8 052782 043692</p> <p>Box of 50</p>	<p>AGB*^(IT)</p> <p>AL AHRAM*^(EG)</p> <p>BANHAM*^(GB)</p> <p>BEST*^(US)</p> <p>CISA*^(IT)</p>
BEST*	CISA*		<p>(*) This is a trademark of a third party not affiliated nor linked with Silca S.p.A. or the dormakaba Group. Silca S.p.A. and dormakaba Group do not own any intellectual property right nor have been granted any license with regard to such trademark, which is hereby used only to indicate the intended purpose of Silca's products.</p>
 <p>445</p> <p>BES23 TB</p>  <p>8 052782 044781</p> <p>Box of 100</p>	 <p>11</p> <p>CS190</p>  <p>8 052782 043708</p> <p>Box of 100</p>	 <p>11</p> <p>CS191</p>  <p>8 052782 043715</p> <p>Box of 100</p>	











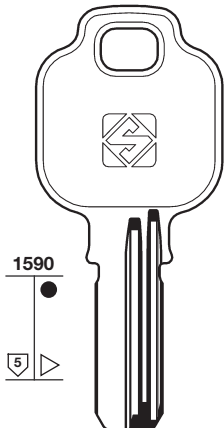

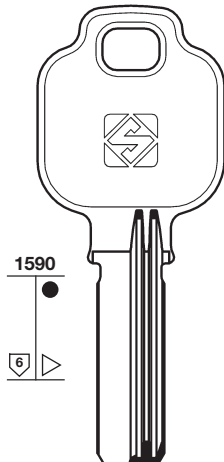

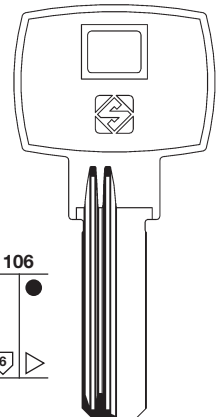
2024 NEW KEYS COLLECTION

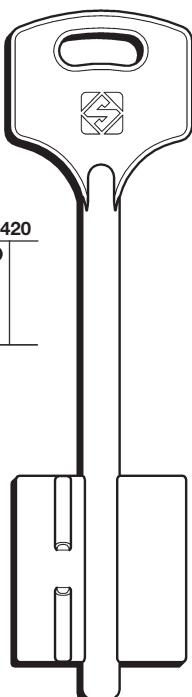
NEW KEYS

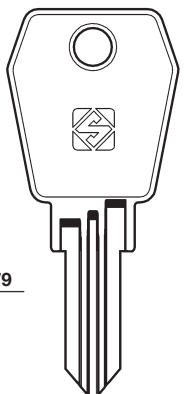

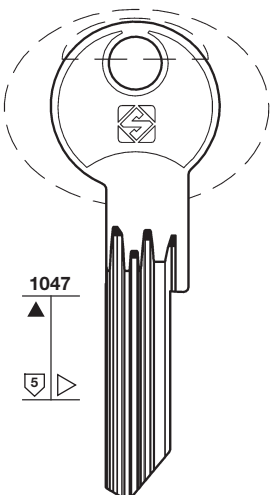
Silca key blanks are compatible with third party manufacturers' cylinders specified here below:

DABEL*		
 <p>1590</p> <p>5</p>  <p>DBL1</p>  <p>8 052782 042084</p> <p>Box of 50</p>	 <p>1590</p> <p>6</p>  <p>DBL3</p>  <p>8 052782 043449</p> <p>Box of 50</p>	 <p>106</p> <p>6</p>  <p>DBL2R</p> <p>8 052782 042091</p> <p>Box of 50</p>
ELBOR*	EURO LOCKS*	FAB*
 <p>1420</p> <p>NEW</p>  <p>5EB9</p> <p>8 052782 043685</p> <p>Box of 25</p>	 <p>879</p> <p>7</p>  <p>EU25</p> <p>8 052782 043722</p> <p>Box of 100</p>	 <p>1047</p> <p>5</p>  <p>FB143X</p> <p>8 052782 042503</p> <p>Box of 50</p>

DABEL* (RS)

ELBOR* (RU)

EURO LOCKS* (BE)

FAB* (CZ)

(*) This is a trademark of a third party not affiliated nor linked with Silca S.p.A. or the dormakaba Group. Silca S.p.A. and dormakaba Group do not own any intellectual property right nor have been granted any license with regard to such trademark, which is hereby used only to indicate the intended purpose of Silca's products.



2024 NEW KEYS COLLECTION

NEW KEYS



Silca key blanks are compatible with third party manufacturers' cylinders specified here below:

FUARO*

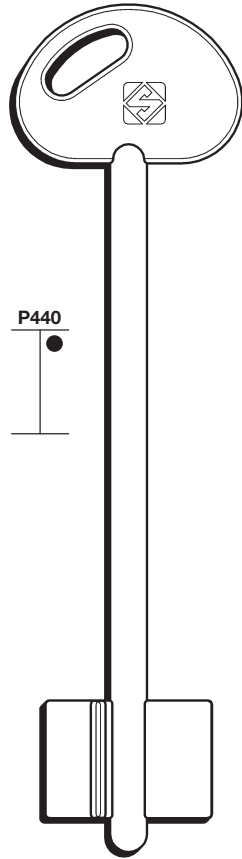

NEW



5FUR1



8 052782 043661

Box of 25

FUARO* (RU)

GENERAL MOTORS* (US)

GENERAL MOTORS*

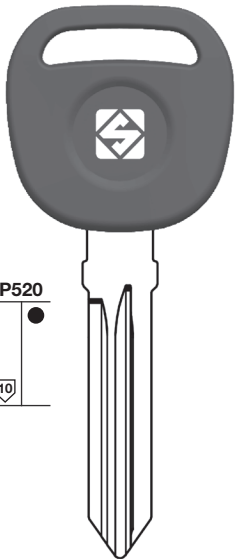

P520



B111P



8 052782 041735

Box of 25

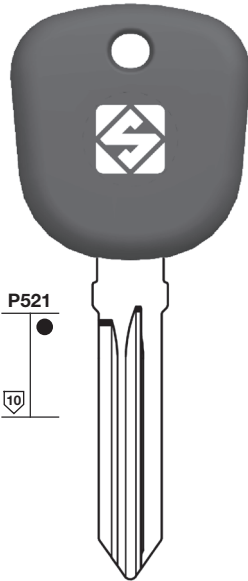

P521



B111TE



8 052782 042602

Bag of 1



8 052782 042619

Bag of 5

(*) This is a trademark of a third party not affiliated nor linked with Silca S.p.A. or the dormakaba Group. Silca S.p.A. and dormakaba Group do not own any intellectual property right nor have been granted any license with regard to such trademark, which is hereby used only to indicate the intended purpose of Silca's products.



2024 NEW KEYS COLLECTION

NEW KEYS



Silca key blanks are compatible with third party manufacturers' cylinders specified here below:

HUF*			HUF* (DE)
			HYUNDAI* (KR)
			ITAL* (IT)
HU66CH1	HU134CH	HU58TE	KIA* (KR)
Pack of 1	Pack of 1	Box of 5	
HYUNDAI*	ITAL*	KIA*	
HYN20CH	5IT9	KIA9CH	
Pack of 1	Box of 25	Pack of 1	

(*) This is a trademark of a third party not affiliated nor linked with Silca S.p.A. or the dormakaba Group. Silca S.p.A. and dormakaba Group do not own any intellectual property right nor have been granted any license with regard to such trademark, which is hereby used only to indicate the intended purpose of Silca's products.











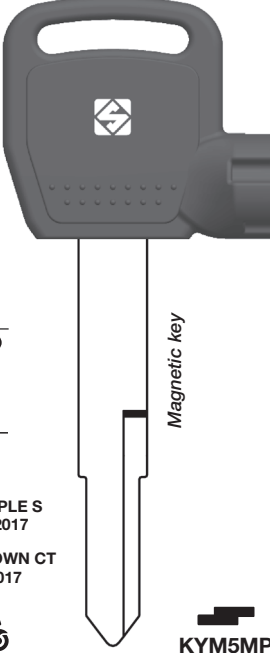

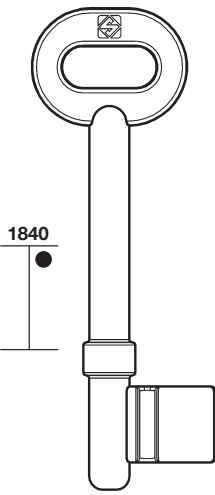

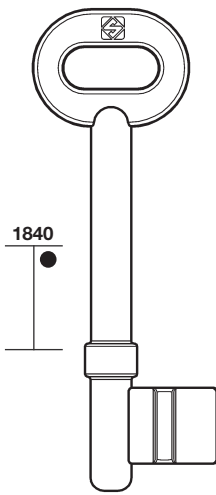

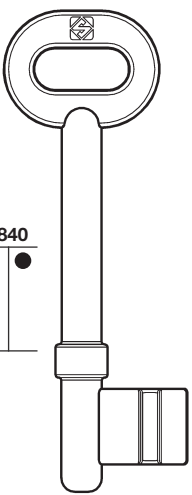
2024 NEW KEYS COLLECTION

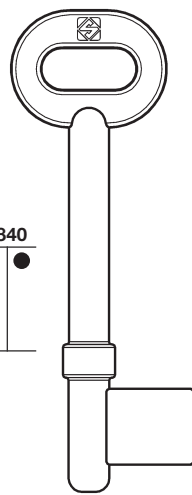
NEW KEYS

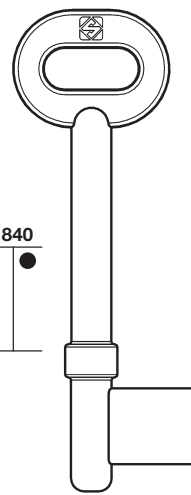

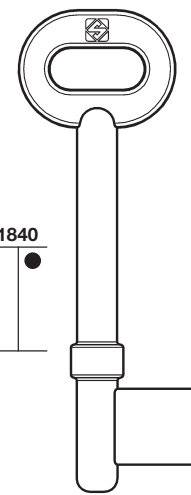
Silca key blanks are compatible with third party manufacturers' cylinders specified here below:

KYMCO*	LEGGE*			
 <p>Magnetic key</p> <p>Model: PEOPLE S Year: 2012-2017</p> <p>Model: X-TOWN CT Year: from 2017</p>   <p>8 052782 044200</p> <p>Box of 10</p>	 <p>1840</p>  <p>6LEG1-B1</p> <p>8 052782 039664</p> <p>Box of 25</p>	 <p>1840</p>  <p>6LEG1-B2</p> <p>8 052782 039671</p> <p>Box of 25</p>	<p>KYMCO* (KR)</p> <hr/> <p>LEGGE* (GB)</p>	
LEGGE*				
 <p>1840</p>  <p>6LEG1-B3</p> <p>8 052782 039688</p> <p>Box of 25</p>	 <p>1840</p>  <p>6LEG1-B4</p> <p>8 052782 039695</p> <p>Box of 25</p>	 <p>1840</p>  <p>6LEG1-B5</p> <p>8 052782 040608</p> <p>Box of 25</p>	 <p>1840</p>  <p>6LEG1-B6</p> <p>8 052782 040615</p> <p>Box of 25</p>	<p>(*) This is a trademark of a third party not affiliated nor linked with Silca S.p.A. or the dormakaba Group. Silca S.p.A. and dormakaba Group do not own any intellectual property right nor have been granted any license with regard to such trademark, which is hereby used only to indicate the intended purpose of Silca's products.</p>



2024 NEW KEYS COLLECTION

NEW KEYS



Silca key blanks are compatible with third party manufacturers' cylinders specified here below:

LOCKWOOD*

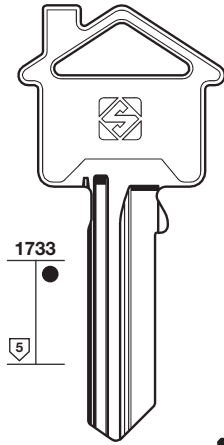

LW4BB



8 052782 043074
Box of 10

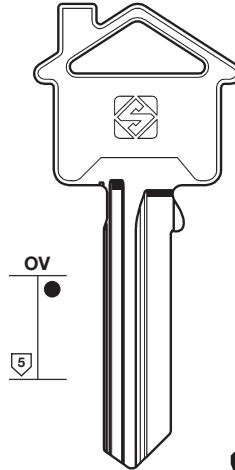

LW5BB



8 052782 043098
Box of 10

LOCKWOOD* (AU)

MOTTURA* (IT)

MOTTURA*

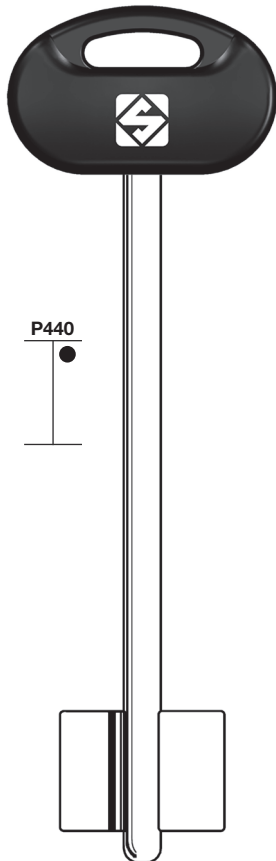

5MT29BP



8 052782 042176
Box of 25

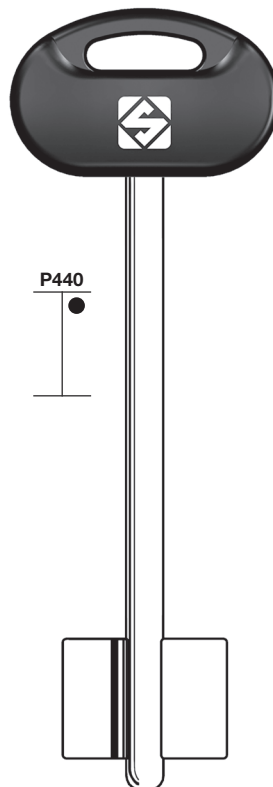

5MT27BP



8 052782 042169
Box of 25

(*) This is a trademark of a third party not affiliated nor linked with Silca S.p.A. or the dormakaba Group. Silca S.p.A. and dormakaba Group do not own any intellectual property right nor have been granted any license with regard to such trademark, which is hereby used only to indicate the intended purpose of Silca's products.



2024 NEW KEYS COLLECTION

NEW KEYS



Silca key blanks are compatible with third party manufacturers' cylinders specified here below:

NEMEF*		POWERLOCK*	NEMEF* (NL) POWERLOCK* (DE) SUZUKI (JP) TITAN* (SI) UNIVERSAL
 1841 6NFH2L 8 052782 041377 Box of 25	 1841 6NFH4L 8 052782 041384 Box of 25	 1385 Lock Systems: PL-700 POW1 70 mm 8 052782 042039 Box of 50	
SUZUKI*	TITAN*	UNIVERSAL*	
 Magnetic key Model: BURGMAN Year: from 2007 SZ29RMP 8 052782 044217 Box of 10	 1768 TN58 8 052782 043456 Box of 50	 A 5 8,7 mm UL066 8 052782 043746 Box of 100	

(*) This is a trademark of a third party not affiliated nor linked with Silca S.p.A. or the dormakaba Group. Silca S.p.A. and dormakaba Group do not own any intellectual property right nor have been granted any license with regard to such trademark, which is hereby used only to indicate the intended purpose of Silca's products.



2024 NEW KEYS COLLECTION

NEW KEYS



Silca key blanks are compatible with third party manufacturers' cylinders specified here below:

VACHETTE*

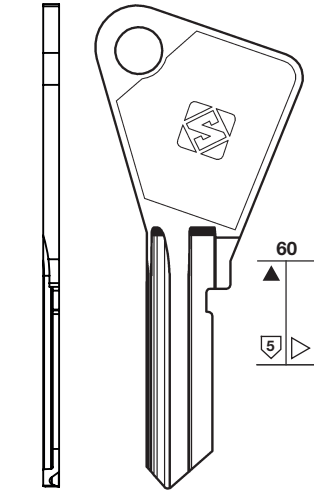

Shoulder milling view



VAC2SM



8 052782 033013

Box of 50

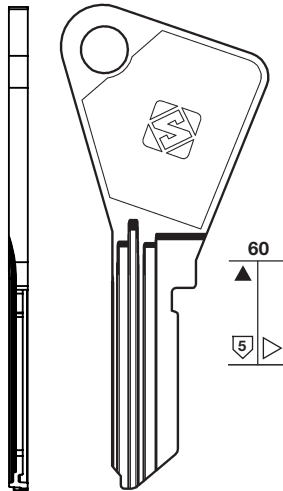

Shoulder milling view



VAC48SM



8 052782 032924

Box of 50

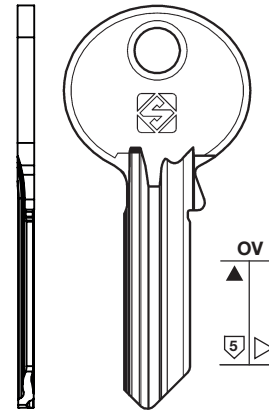

Shoulder milling view



VAC151SM



8 052782 032894

Box of 50

VACHETTE* (FR)

YALE* (GB)

YALE*

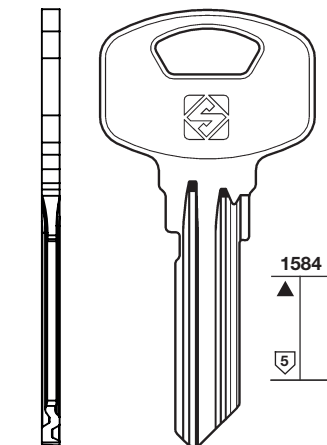

Shoulder milling view

Orig. code: 1109



YA116SM



8 052782 043968

Box of 50

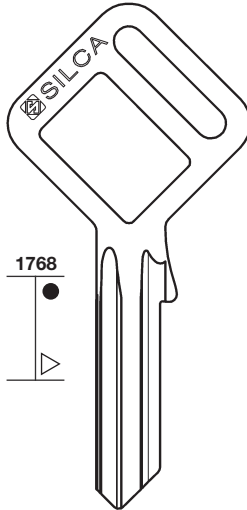

1768



YA226FZ



8 052782 042527

Box of 50 - Assorted colours

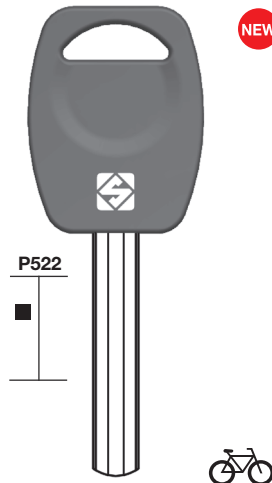

P522



YA117P



8 052782 043272

Box of 5

(* This is a trademark of a third party not affiliated nor linked with Silca S.p.A. or the dormakaba Group. Silca S.p.A. and dormakaba Group do not own any intellectual property right nor have been granted any license with regard to such trademark, which is hereby used only to indicate the intended purpose of Silca's products.



2024 NEW KEYS COLLECTION

NEW KEYS



Silca key blanks are compatible with third party manufacturers' cylinders specified here below:

ZADI*

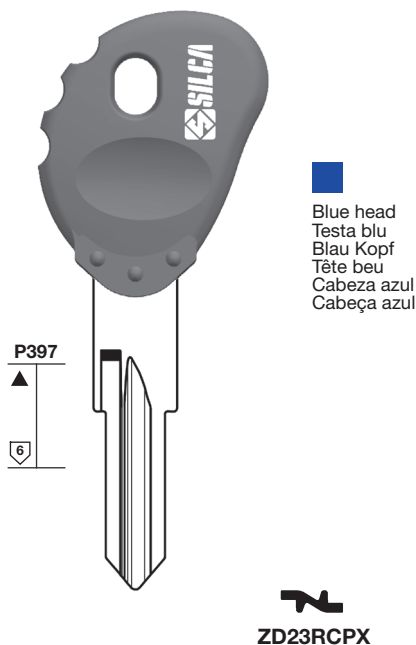
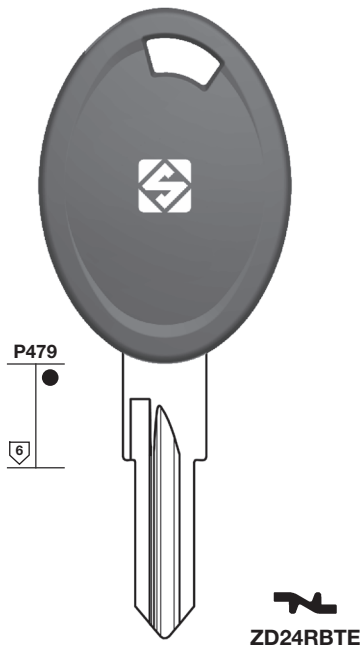

ZADI* (IT)

ZEISS IKON (DE)

ZEISS IKON*

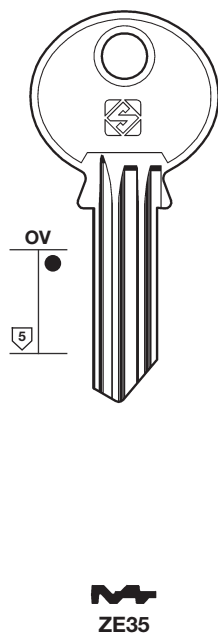
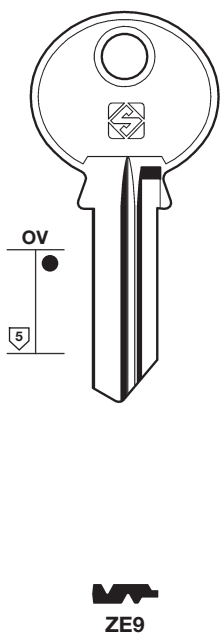

(*) This is a trademark of a third party not affiliated nor linked with Silca S.p.A. or the dormakaba Group. Silca S.p.A. and dormakaba Group do not own any intellectual property right nor have been granted any license with regard to such trademark, which is hereby used only to indicate the intended purpose of Silca's products.